

OMAH

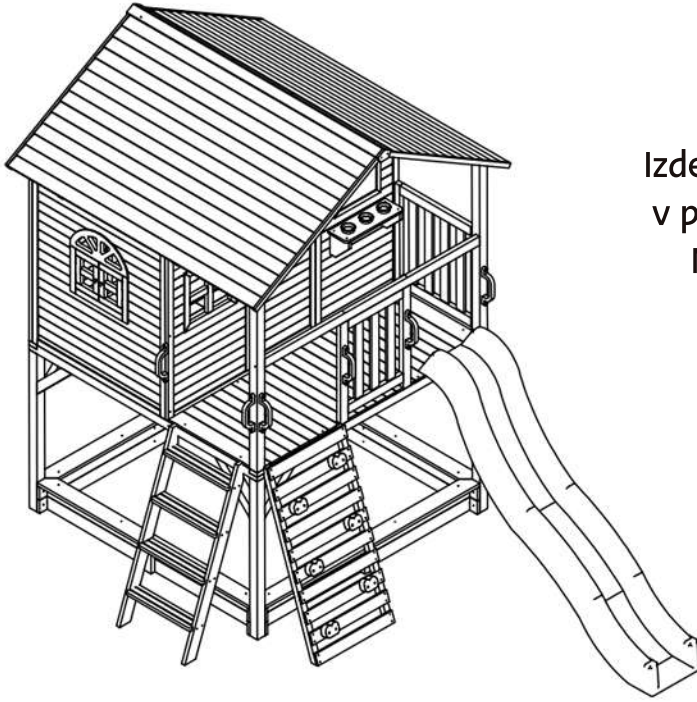







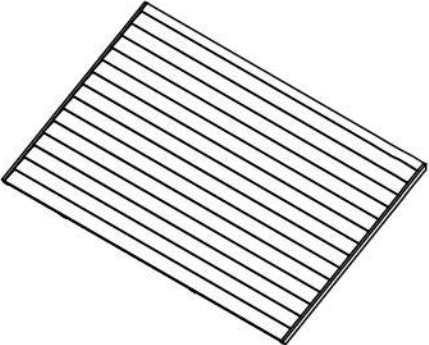
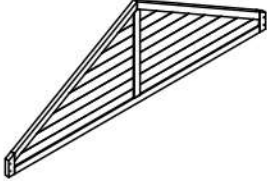
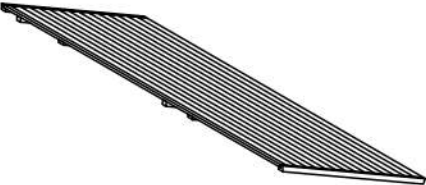
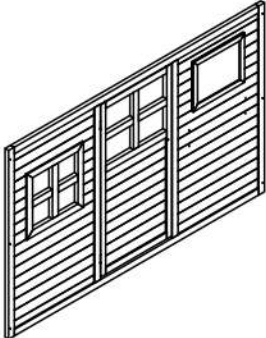
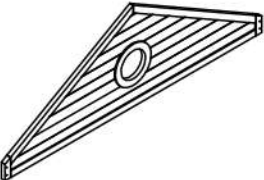
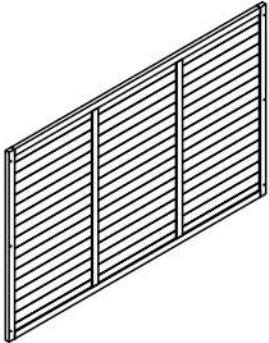







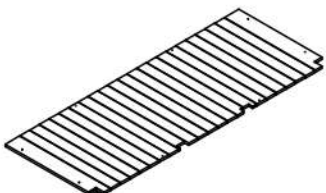

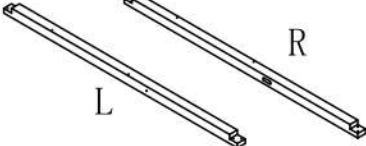



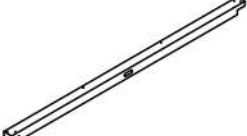

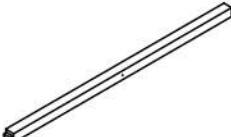





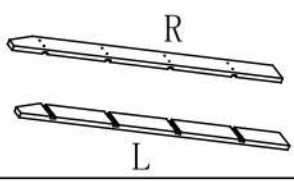



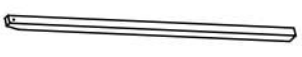





OPOZORILO:

Izdelek mora biti dovolj dobro zasidran v podlago (odvisno od vrste podlage).

Nevarnost prevrnitve, npr. zaradi močnega vetra.

1		1x	4		1x
2		1x	5		1x
3		1x	6		1x

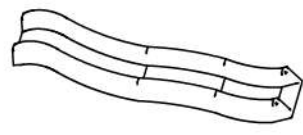
7		2x	15		1x
			16		1x
8		2x	17		2x
			18		4x
9		1x	19		8x
			20		2x
10		2x	21		1x
11		1x	22		1x
12		2x	23		1x
13		1x	24		1x
14		2x	25		1x

26		2x	D	 3.5x45mm	32
27		4x	E	 3.5x60mm	63
28		2x	F	 5x70mm	16
29		4x	G	 6x35mm	14
30		6x	H	 M8x30mm	12
31		4x	I	 4x35mm	4
32		8x	J		6
33		4x	K		6
A	 3x28mm	12	L		3
B	 3.5x35mm	88	M		1
C	 3.5x40mm	60	N	 4x30mm	1

1

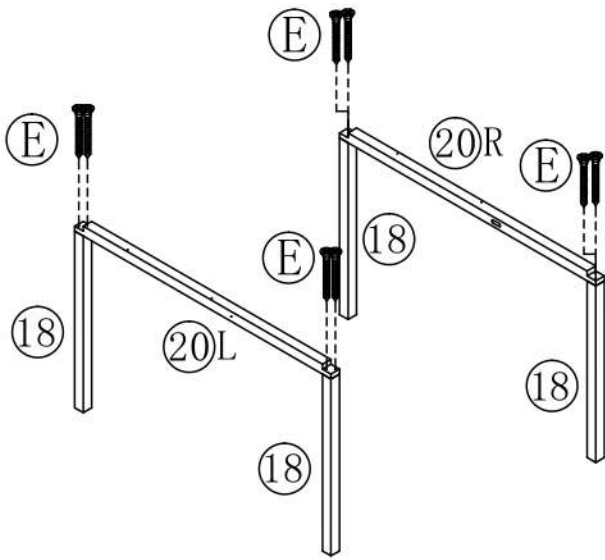

2

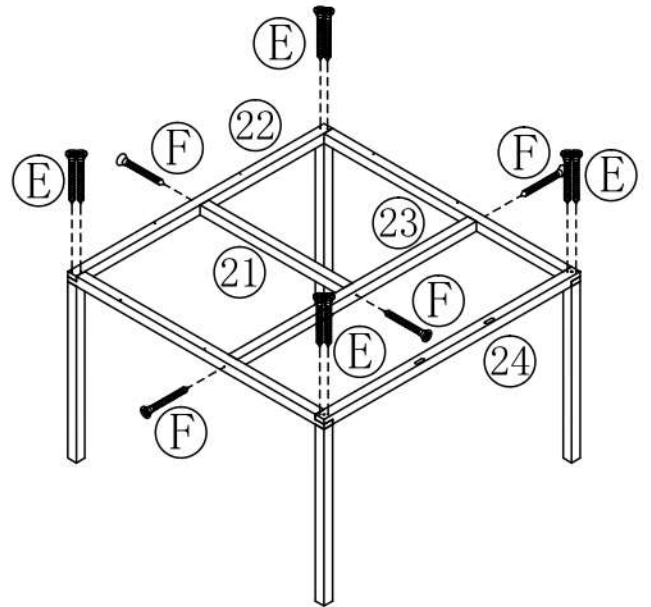

3

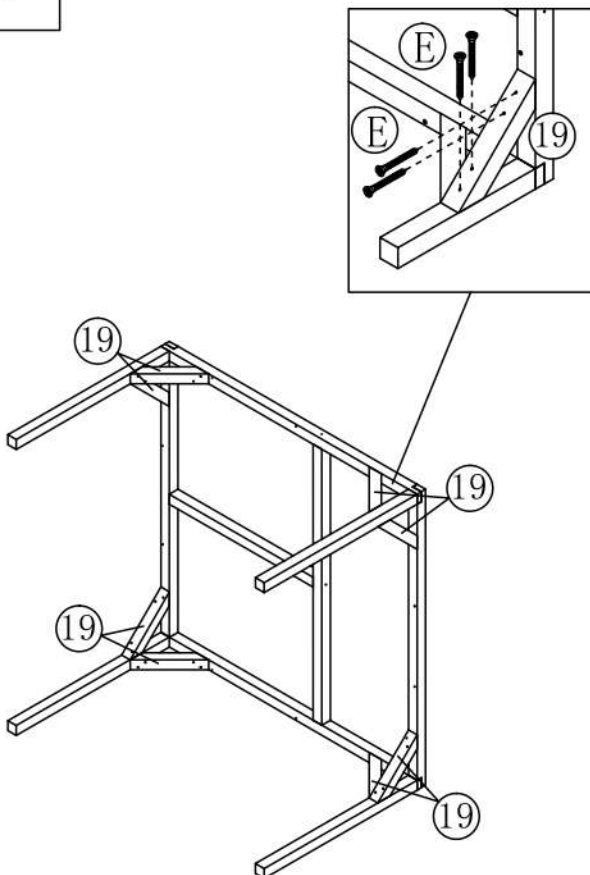

4

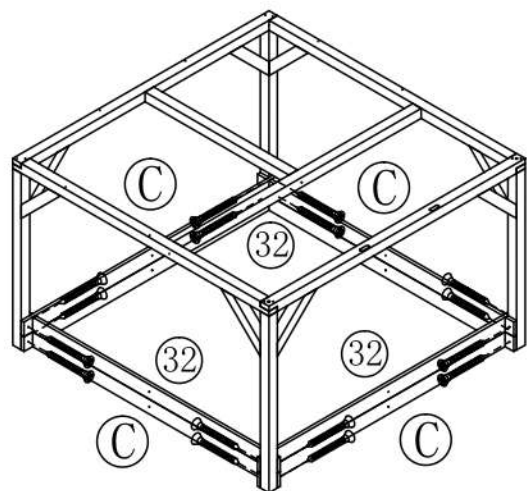

5

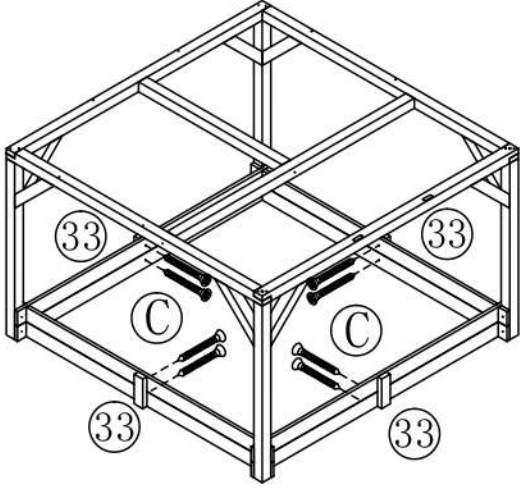

6

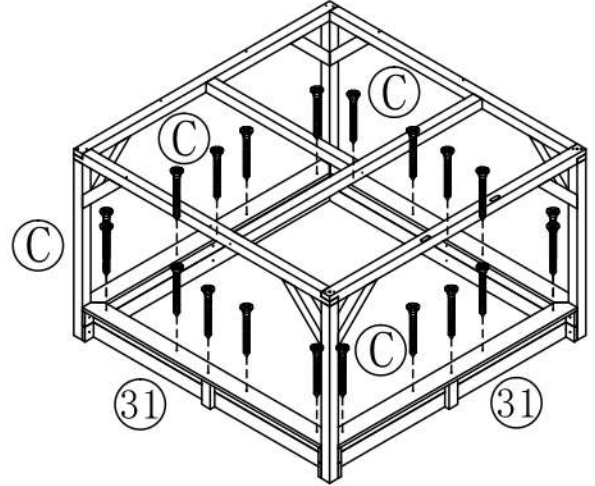

7

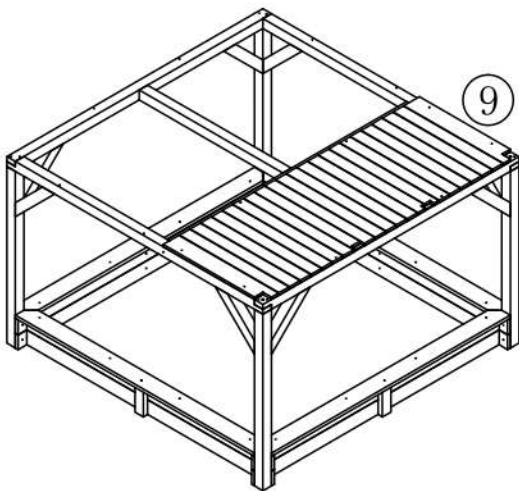

8

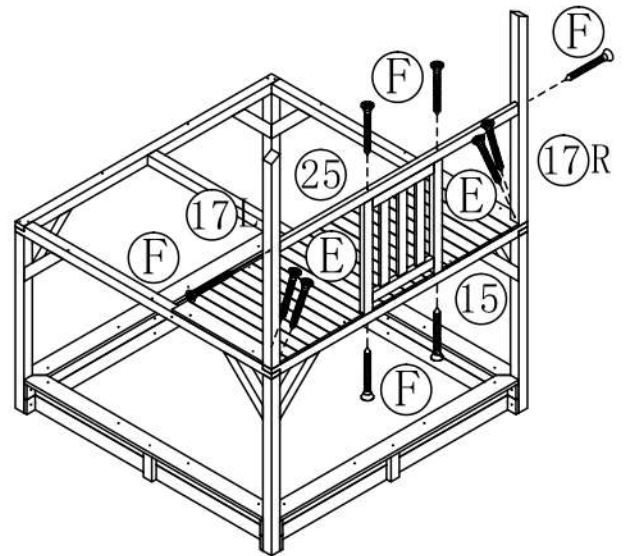

9

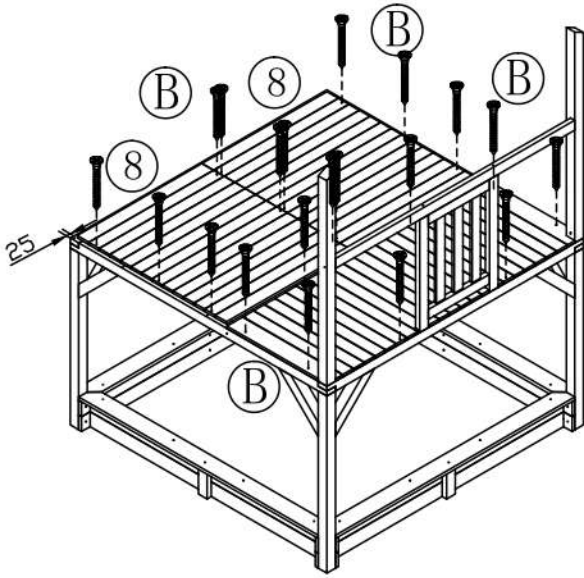

10

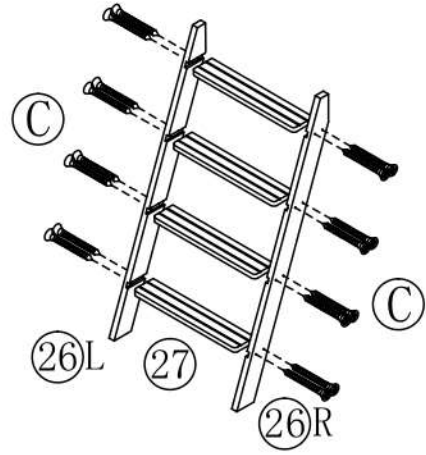

11

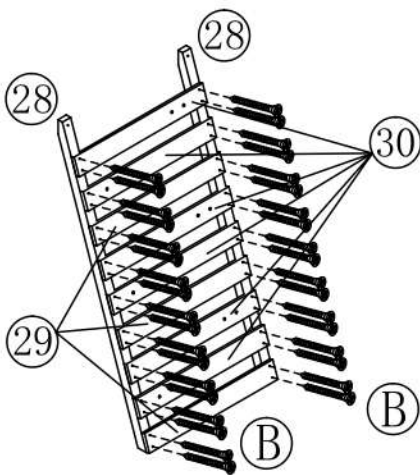

12

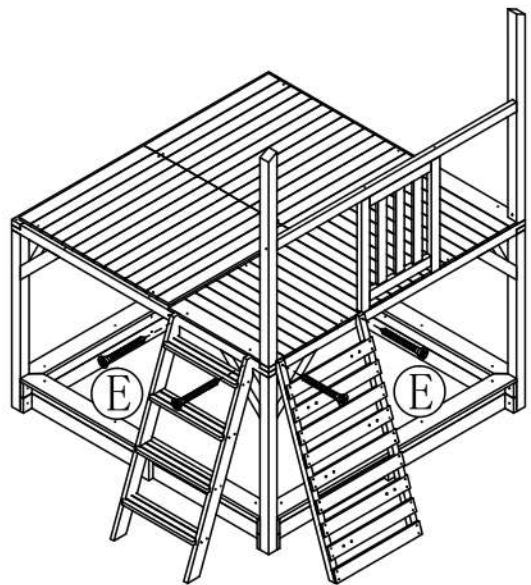

13

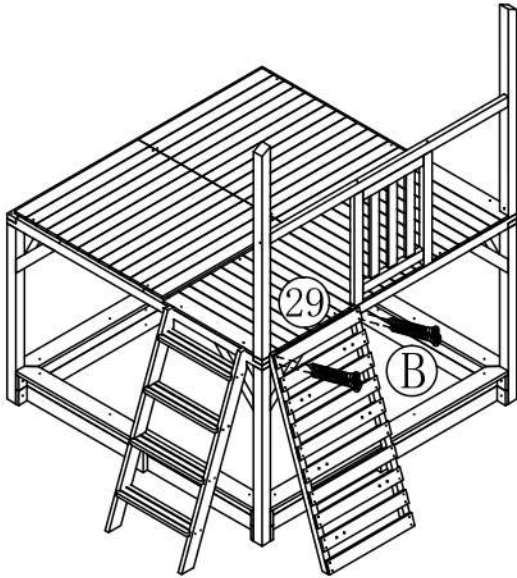

14

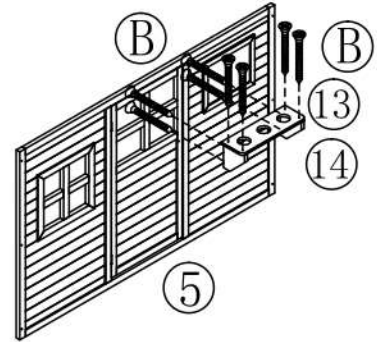

15

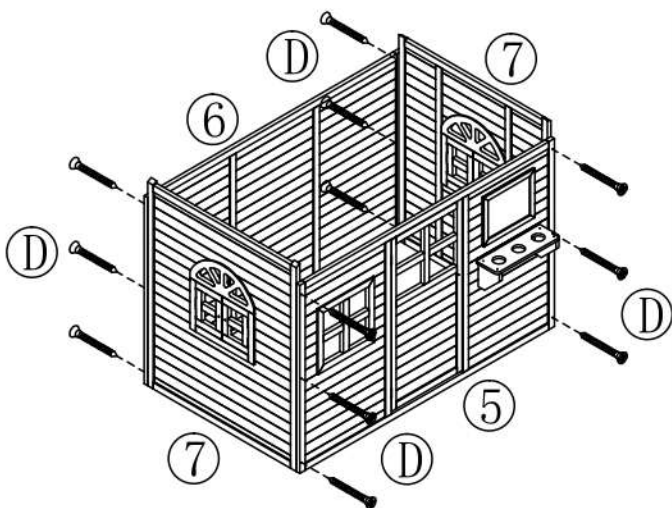

16

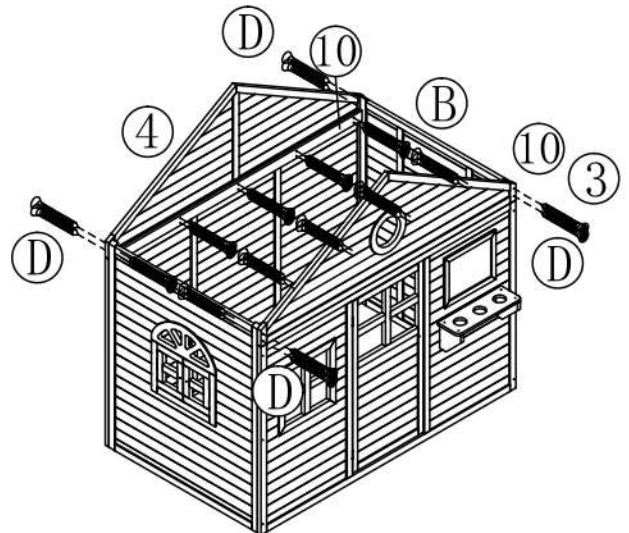

17

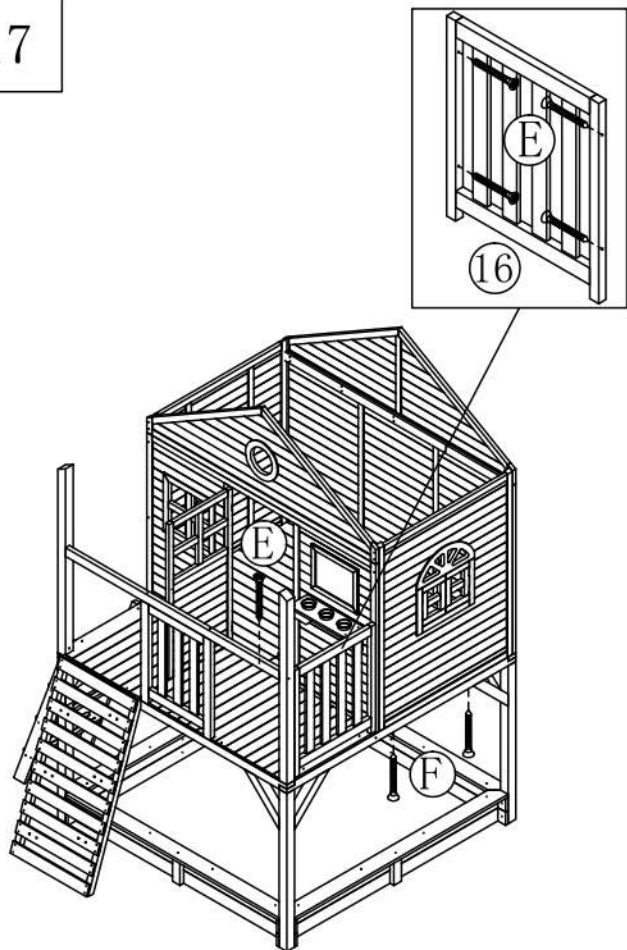

18

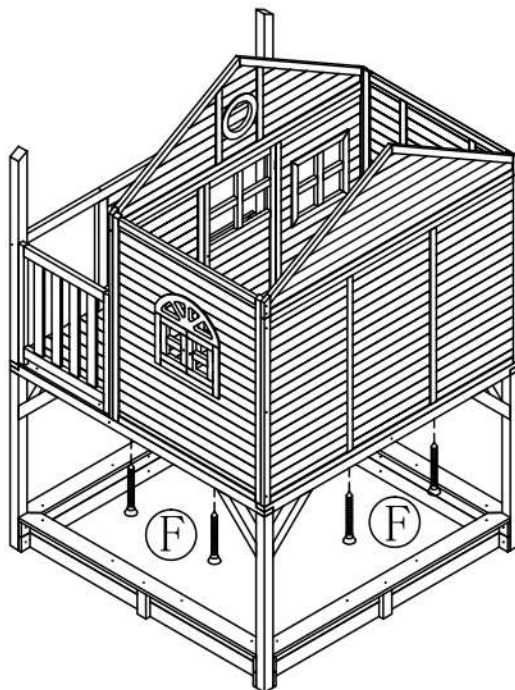

19

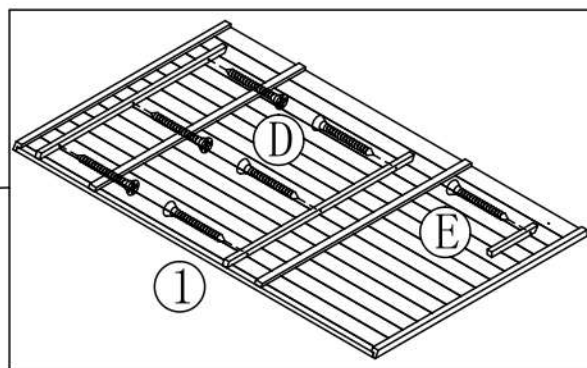
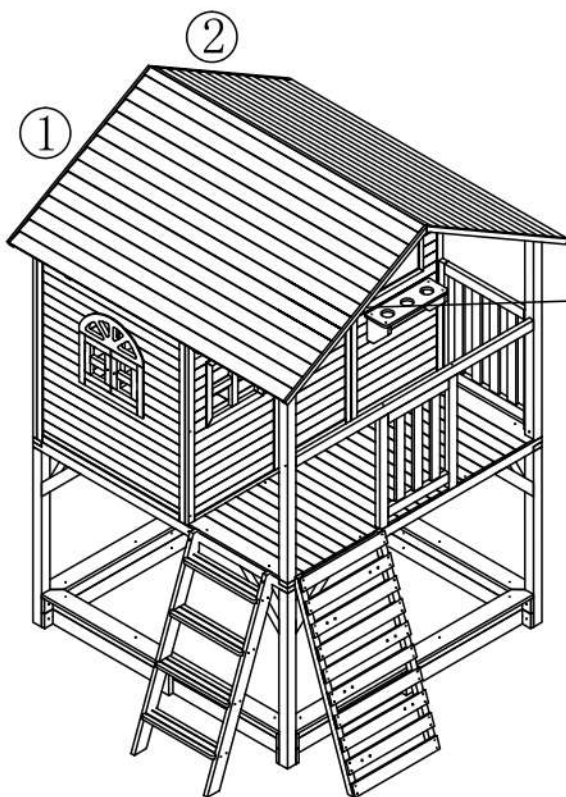

20

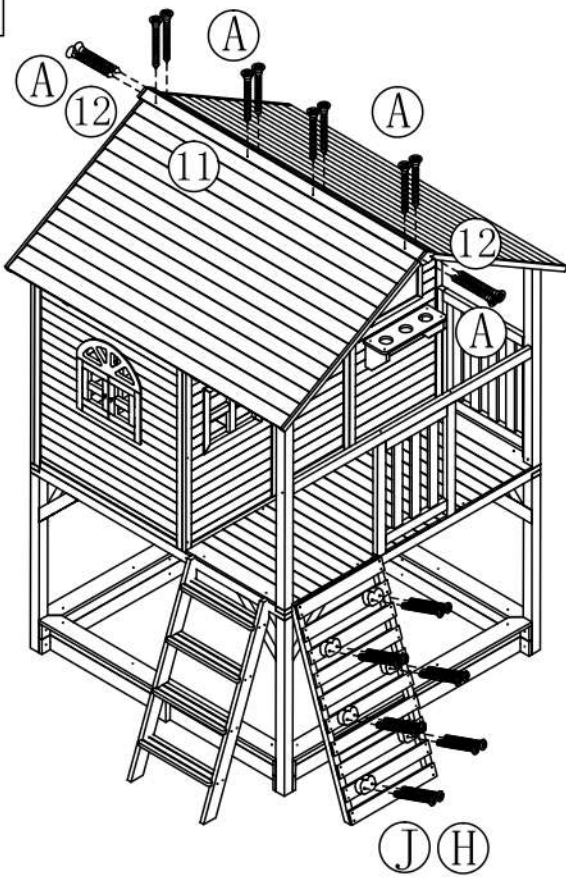

21

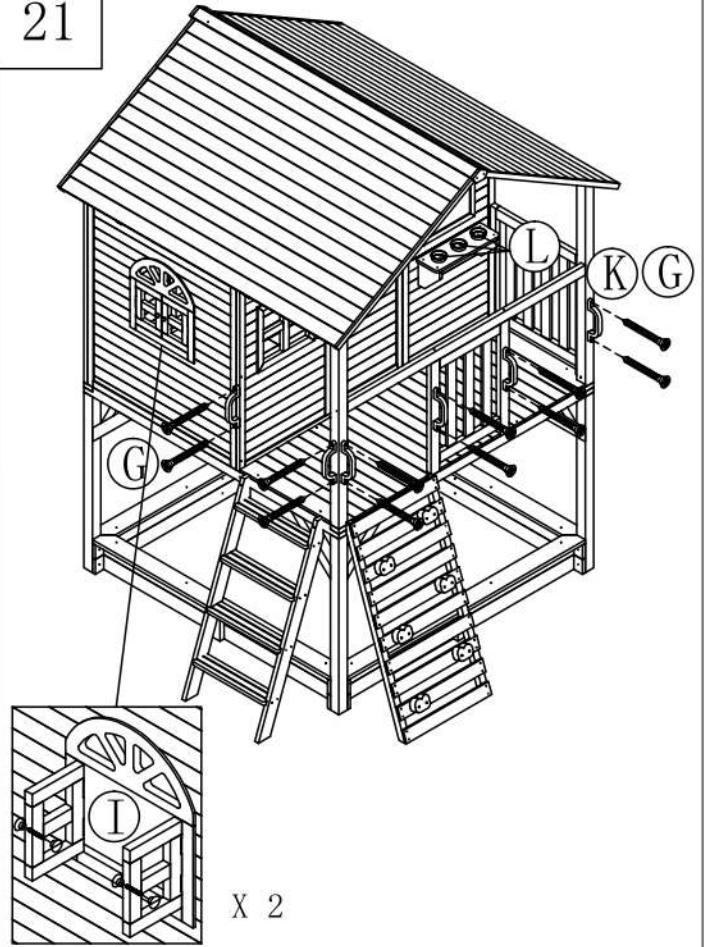

22

